

LASVIT CRYSTAL ROCK TABLE LAMP MANUAL ^{UL}

Crystal Rock Collection
by Arik Levy



Contents

Technical parameters	1
Step-by-step installation	2
Turning ON/OFF	3
Light source replacement	4
Warranties and Warranty Terms and Conditions	5

Markings



Warns you of high risk of damage to the fixture or injury.



Warns you of high risk of electrical injury should a live part be directly or indirectly touched.



Warns you about possible damage to the fixture.



Important information regarding the usage of your fixture.



Gives you general information about the usage of your fixture.

Please read this manual carefully and keep it in case you need assistance while performing maintenance and cleaning procedures.

1/ Technical parameters

Item ID / CL017TA-1UL

Dimensions / $7\frac{7}{8}$ " x $7\frac{3}{8}$ " x $5\frac{7}{8}$ "

Color variants / blue, clear, light amber, opal, red

Weight / approx. 6,6 lb

Input voltage / 100 – 120 V AC, 50/60 Hz

Rated power / max. 2 W

Light source / 1 x LED module

Protection rating / IP 20

Safety class / CLASS II

Please read this manual carefully and keep it in case you need assistance while performing maintenance and cleaning procedures.

2/ Step-by-step installation

 Before starting any procedures make sure that the power cable of the lamp is disconnected from the socket, power is switched OFF and secured against unauthorized, negligent or accidental switching on.

 If the power cable of the luminaire is damaged, it shall be replaced by the manufacturer or a similar qualified person only in order to prevent any damage to health or property.

 To retain quality of hand-blown glass, Lasvit recommends to clean the glass at least every 3 months.

 The manufacturer shall not be held liable for any defects caused by unqualified handling of the lamp.

 Do not cover the lamp with any material, it is necessary for the hot parts to be cooled by freely flowing air, otherwise there is a risk of fire.

 For indoor use only. Installation requires 1 persons.

3/ Turning ON/OFF

 Connect the power cable (position A) to the socket and turn the light on (position B).

 For turning ON/OFF use the switch (pos B).

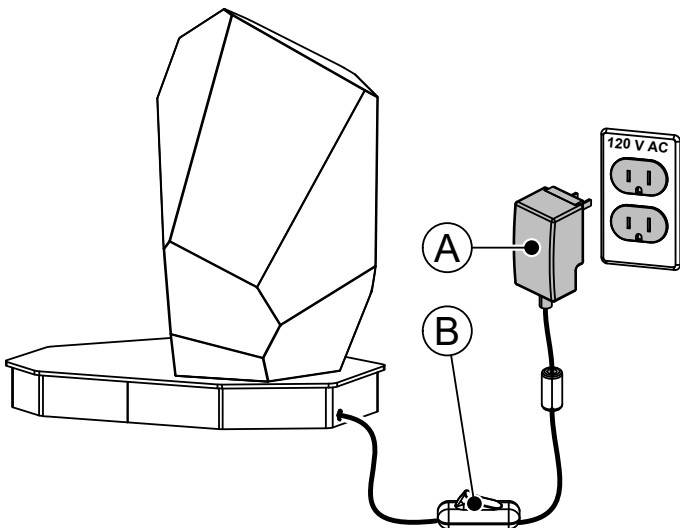

4/ Light source replacement



In case of light source failure, please contact the Lasvit manufacturer.

5/ Warranties and Warranty Terms and Conditions

1/ The warranty is defined in the Price Quotation, Price Agreement, Contract, or Order. If the Price Quote, contract, or order is not issued, the warranty does not apply to resources, maintenance, service and cleaning and the standard warranty on the goods is set for 2 years. Other agreed warranties must be specified in the Price Quotation, Price Agreement, Contract, or Order.

2/ As a basis for the claim, the customer must provide a valid contract, invoice, or other proof of payment. Otherwise, the manufacturer reserves the right to refuse to provide a warranty, so keep the proof of product purchase carefully.

3/ If the warranty applies to the defect found, the customer informs the seller by e-mail, telephone, or the Sales department of the manufacturer (Lasvit) and passes the required information (project number or light number, project or light name and describes the defect).

4/ The Sales Department proceeds on the basis of an internal customer complaint resolution directive.

5/ The manufacturer will analyse the occurrence of a disagreement with the customer or with the manufacturer after delivery of the non-conforming product to the manufacturer's premises.

6/ Once the analysis has been made, the Sales department is handed over the decision to accept or reject the complaint with an explanation.

7/ The Sales department agrees with the customer for further steps (e.g. repair or replacement date, etc. on the basis of customer and manufacturer possibilities). Unless otherwise agreed, the manufacturer is obliged to remove the defect within 30 days of the claim date at the manufacturer's expense.

8/ The warranty does not apply to:

- defects caused by the customer
- defects caused by a third party
- defects caused by regular usage
- defects caused by an installation contrary to the installation manual
- defects caused by inappropriate attachment or product connection
- defects caused by performed in contradiction with the cleaning manual

- defects caused by the use of other than defined light sources
- defects caused by installation in premises that do not correspond to the nature of the light and its IP cover (intrusion protection).
- defects caused by force majeure

9/ The company LASVIT has the exclusive right to grant, deny or change the terms and conditions for the provision of warranty services.



Never dispose of this product in mixed municipal waste, it must be submitted at the designated disposal installation.

The fixture was designed and manufactured by /
Lasvit s.r.o. / Komunardů 32 / 170 00 Praha 7 /
Czech Republic T +420 481 120 810 / F +420 481 120 622 /
E lasvit@lasvit.com lasvit.com

Manual created

10.07.2020

In case you need any assistance or have
any suggestion, please contact us at

lasvit.com