

LASVIT FLOOR LAMP LA SCALA MANUAL CE

Neverending Glory collection
by Jan Plecháč & Henry Wielgus

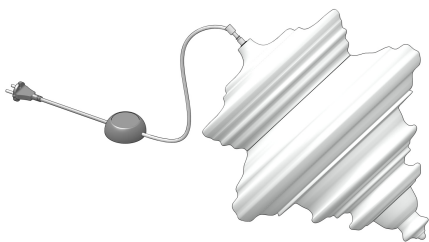

Contents

Technical parameters	1
Step-by-step installation	2
Installation	3
Light source replacement	6
Warranties and Warranty Terms and Conditions	7

Markings

 Warning

Warns you of high risk of damage to the fixture or injury.

 Risk of electrical injury.

Warns you of high risk of electrical injury should a live part be directly or indirectly touched.

 Notice

Warns you about possible damage to the fixture.

 Important

Important information regarding the usage of your fixture.

 Note

Gives you general information about the usage of your fixture.

Please read this manual carefully and keep it in case you need assistance while performing maintenance and cleaning procedures.

1/ Technical parameters

Item ID / CL008FC-1CE

Light source / 1 × E14, max. 20W

Input voltage / 220 – 240 V, 50 / 60Hz

Rated power / max. 20W

Protection rating / IP 20

Safety class / CLASS II

Dimensions / 395 mm x Ø 447mm

Weight / approx. 9 kg

Please read this manual carefully and keep it in case you need assistance while performing maintenance and cleaning procedures.

2/ Step-by-step installation

 Before starting any procedures make sure that the power to the lighting fixture is switched OFF and secured against unauthorized, negligent or accidental switching on.

 Should the cable need to be shortened, ask a qualified technician (licensed electrician) to disconnect the cable, shorten it and reconnect it. The same applies to lengthening the cable, however a new, longer cable needs to be purchased separately. Lasvit shall not be held liable for any injuries or damage to the fixture or other property caused by unauthorised manipulation with the cable or its parts.

 To retain quality of hand-blown glass, Lasvit recommends to clean the glass at least every 3 months.

 Fixing material is not part of the lighting fixture kit. Refer to the relevant section of this manual for suitable fixing materials and components.

 Proper fixing shall be the responsibility of the customer.

 Installation and electrical wiring should be carried out by a qualified electrician to prevent any damage to health or property.

 The manufacturer shall not be held liable for any defects caused by unqualified handling of the lighting fixture.

 This lighting fixture is to be mounted on fire proof surfaces.

 Do not cover the lighting fixture with any material, it is necessary for the hot parts to be cooled by freely flowing air, otherwise there is a risk of fire.

 For indoor use only. Installation requires 1 persons.

3/ Installation

Step 1

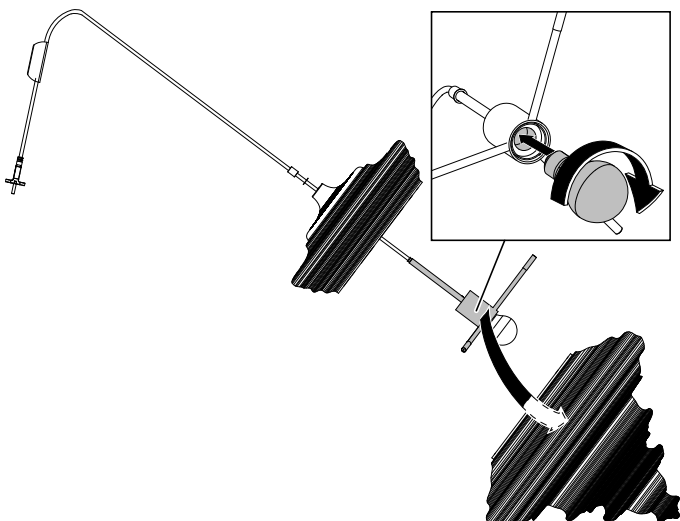

Step 2

⚠ Tripoid (pos A) keep in tension by hanging its power cable (pos B) ,so the tripod cañt fall into the bottom glass component ,(pos D) to prevent any damage of the light source (pos E). Pay attention on slip of the top glass component (pos C) on the power cable, it can be damaged by the tripod.

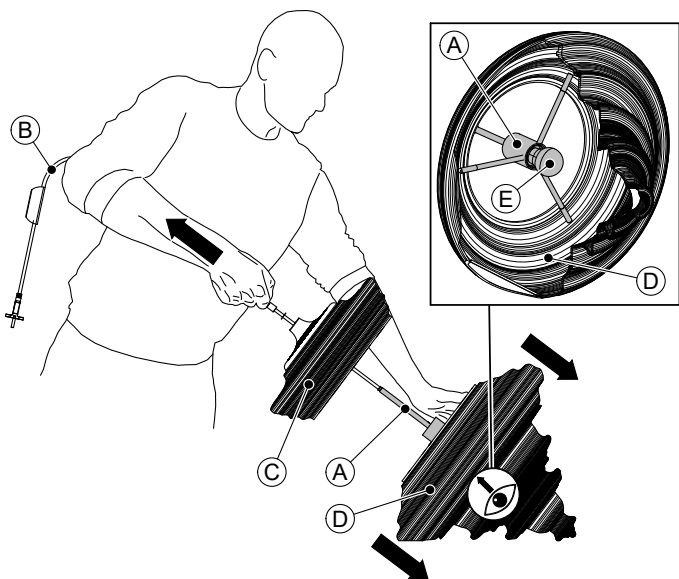

Step 3

! Top glass component (pos C) must be softly installed on the bottom glass component (pos D) to prevent any damage of glass components.

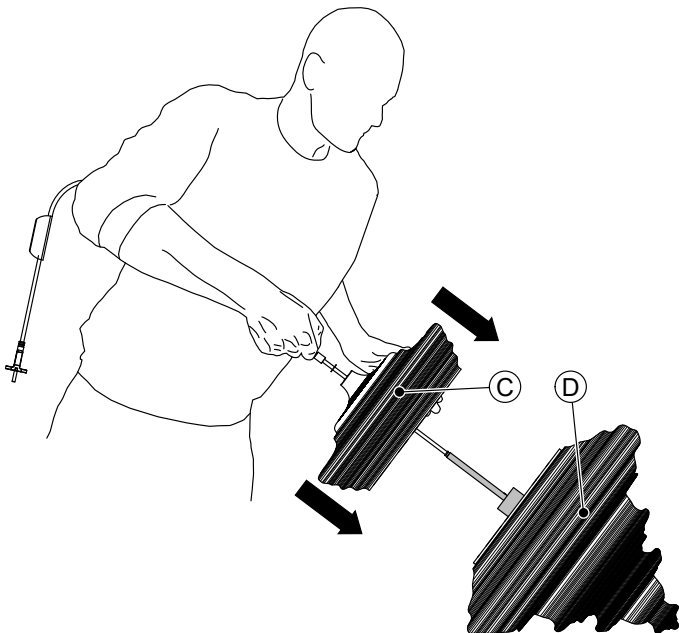

Step 4

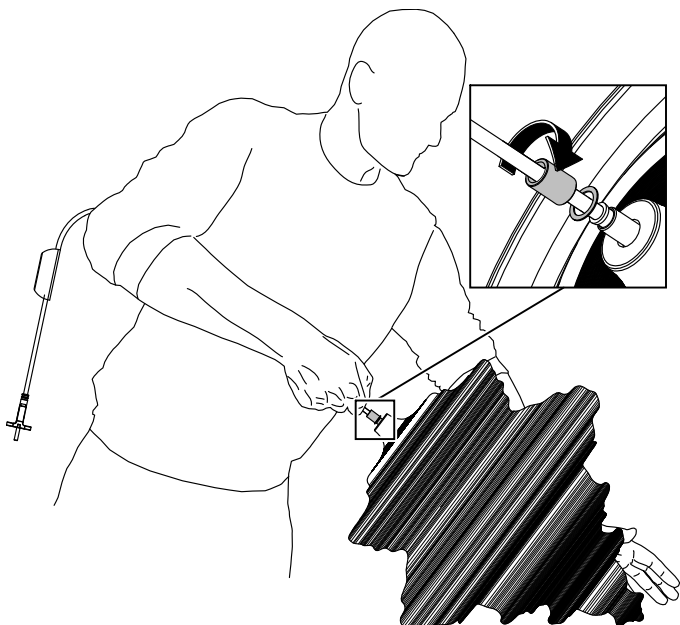

Step 5

! For turning ON/OFF use the switch (pos F).

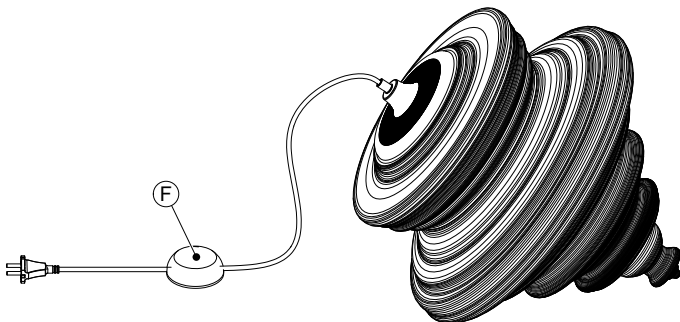

4/ Light source replacement

All light sources can be supplied by the manufacturer, Lasvit s.r.o.

Replacement of the bulb should be carried out by qualified technician to prevent damage to health or property.

Lasvit provides NO warranty on bulbs and is not responsible for any damage or injury caused during its installation or during its operation.

Before starting installation make sure the power to the lighting fixture is switched OFF and secured against unauthorized, negligent or accidental switching on.

The manufacturer shall not be held responsible for injuries, damage to the fixture and/ or other property when other than specified light source type and/ or rating is used.

Carry out this step in reverse to fit the new bulb.

Plug in the light again.

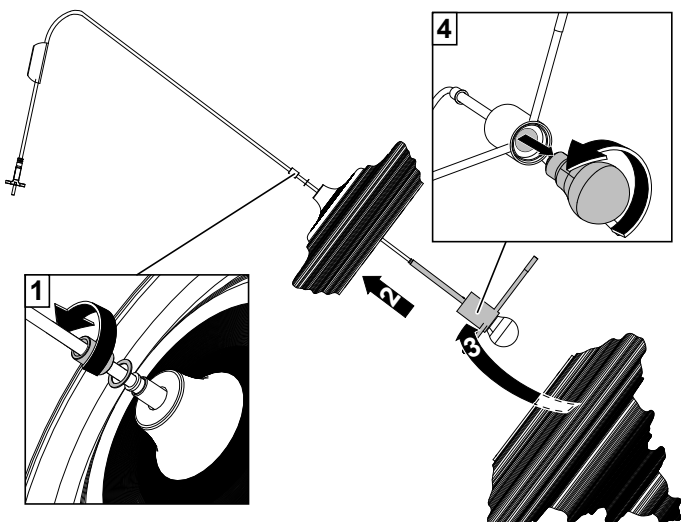

5/ Warranties and Warranty Terms and Conditions

1. The warranty is defined in Price Quotation (PQ) or in Purchase Agreement (PA). If **not stated otherwise**, the warranty shall not cover the **light sources**, maintenance, service and cleaning and the standard warranty shall be set at 2 years. Any other warranties must be specified in PQ or PA. The Customer must submit a valid agreement, invoice or another payment document as a base for any complaint.
2. If the warranty covers the detected defect, the Customer shall inform Sales (by e-mail or phone, defining the project / product number, the project / product name, the areas where the defect has emerged, and the sketch number. The Customer shall describe the defect).
3. Sales shall proceed based on the internal guideline for complaint management.
4. The Manufacturer shall analyze the origins of the defect either at the Customer's or at the Manufacturer's, after the defective product has been delivered to the Manufacturer's premises.
5. After the analysis, the decision about acknowledgement or refusal of the complaint and the respective explanation shall be passed on to Sales.
6. Sales shall submit information about acknowledgement / refusal of the complaint to the Customer within 7 workdays from reporting the defect at the latest. Sales shall agree further steps with the Customer (e.g. the date of repair, replacement, etc., based on the Customer's and Manufacturer's capacities). Unless agreed otherwise, the Manufacturer shall eliminate any defect within 30 days from the date of submittal of the complaint.
7. The complaints shall not cover any defects caused by the Customer, normal wear and tear, or by failure to follow the service manual or installation manual. The complaints shall not cover any defects caused by force majeure.
8. **The analysis may lead to the following conclusions:**

Manufacturer's fault:

- The product is repairable at the Customer's at the Manufacturer's cost.

- The product is repairable at the Manufacturer's at the Manufacturer's cost.
- The product is not repairable and shall be replaced by a tested functional one at the Manufacturer's cost.
- The product is not repairable and the Manufacturer cannot offer any replacement. The Manufacturer shall offer another product. The Customer shall accept the offer and settle the new product by a difference payment, or the Manufacturer shall pay a difference payment to the Customer.
- The product is not repairable and the Manufacturer cannot offer any replacement. The Manufacturer shall issue a refund to the Customer.

Customer's fault:

- The product is repairable at the Customer's at the Customer's cost.
- The product is repairable at the Manufacturer's at the Customer's cost.
- The product is not repairable and shall be replaced by a verified and functional one at the Customer's cost.
- The product is not repairable and the Manufacturer cannot offer any replacement. The Manufacturer may offer another product for purchase.





Never dispose of this product in mixed municipal waste, it must be submitted at the designated disposal installation.

The fixture was designed and manufactured by /
Lasvit s.r.o. / Komunardů 32 / 170 00 Praha 7 /
Czech Republic T +420 481 120 810 / F +420 481 120 622 /
E lasvit@lasvit.com lasvit.com

Manual created

26.5.2021

In case you need any assistance or have
any suggestion, please contact us at

lasvit.com